

DIVISION 10 - SPECIALTIES

Includes the following sections:

- 10 11 00 Visual Display Surfaces
- 10 14 00 Signage
- 10 21 13 Toilet Compartments
- 10 28 13 Toilet Accessories
- 10 44 16 Fire Extinguishers

VISUAL DISPLAY SURFACES	10 11 00
--------------------------------	-----------------

Chalkboards and Markerboards: Porcelain-on-steel writing surface.
 Tackboards: Natural cork.

SIGNAGE	10 14 00
----------------	-----------------

The UCSC Campus has a Building Sign Program, located at the end of Division 10 of these Campus Standards. A copy of these guidelines may also be obtained from the University’s Representative. The guidelines:

1. Provide graphic standards for a campus sign program.
2. Provide category classification for all sign types in the program.
3. Assist in identifying which sign type is appropriate to use.
4. Assist in the application and placement of signs.

In interior locations where signs are to be installed using double-sided adhesive tape, the tape shall be applied at the top & bottom as it makes removal easier.

REGULATORY SIGNAGE

Regulatory signs shall comply with all applicable codes in the current California Manual on Uniform Traffic Control Devices (MUTCD). In addition, the signs shall have High Intensity Prismatic Sheeting (HIP) applied.

Plans showing proposed regulatory signage shall be reviewed with the University representative for approval before installation.

TOILET COMPARTMENTS	10 21 13
----------------------------	-----------------

GENERAL

- A. Solid plastic or phenolic core / melamine surface toilet compartments (as well as shower enclosures) are preferred on the UCSC campus in areas of high moisture or humidity such as housing applications due to ease of maintenance and durability. Verify all locations with the Project Manager.
- B. Where privacy is a concern, such as co-ed residence halls, use full length support brackets and door strikes, such that clearances where components join (door to pilaster, pilaster or panel to wall, pilaster to panel, etc.) does not exceed 1/4 inch. Taller doors,

extending from 6" above finish floor to 6'-6" above finish floor, should be considered for such situations. The use of such panels at divider panels, however, can create lighting problems.

- C. Provide extra hardware components for storage and future use by maintenance staff. Amount: 2% or one stall, confirm with Project Manager

MATERIALS

- A. Acceptable Manufacturers:

- 1) Santana Products Company / Poly-Mar HD with Plasti- Glaze 280 finish.
- 2) Capitol Partitions, Inc. / Poly-Pro, or equal.
- 3) Bobrick Washroom Equipment, Inc. / Solid phenolic plastic toilet compartments.

High density polyethylene solid plastic toilet compartments, minimum 1" thick doors and panels, as manufactured by Santana Products, Inc., Comtec Industries, Capitol Partitions, or equal.

- B. Solid Phenolic core / melamine surface toilet compartments, as manufactured by Bobrick Washroom Equipment, Inc., Capitol Partitions, Sanymetal Partitions, or equal.

- C. Doors and panels: Manufacturer's standard solid polymer resin system with surface resistant to pens, pencils, standard markers and paints; cleanable with household detergents: color integral through panels. Doors minimum 24" wide, except where otherwise required for access by persons with disabilities.

- 1) Color: As selected from manufacturer's standard colors.
- 2) Flame Spread Rating: Maximum 50 flame spread and 450 smoke developed, Class II or Class B, ASTM E84 Tunnel Test.

Class II or better flame spread rating. Meet or exceed California Building Code requirements for "Approved Plastic Materials".

- 1) Moisture-resistant
- 2) Shall meet ASTM D6578 for non-ghosting, graffiti-resistant surface
- 3) Shall meet ASTM D2197-13 for scratch resistance
- 4) Shall meet ASTM D2794-93 for impact resistance
- 5) Shall not contain urea-formaldehyde resins

- D. Recycled content shall be a minimum of 20%

- E. Hardware: All hardware shall be vandal-resistant, heavy duty stainless steel (SS) and shall be secured by factory installed inserts. Hardware shall not be secured directly into core.

- 1. Hinges: 16-gauge, self-closing, continuous piano hinge
- 2. Door stop plates: provide two 11-gauge SS stops with rubber bumpers

- F. Material warranty: 25 years

For dispensing accessories, the University has negotiated a contract with a supplier. For general restroom facilities, accessories will be furnished by the University consisting of the following:

1. Liquid soap dispensers: Gojo model #5150-6
2. Paper towel dispensers: Tork model #55 10 282
3. Toilet paper dispensers: Tork model # 55 56 28
4. Filler panel for recessed waste receptacle (see below). The below Tork Intuition filler panel works only with the following recessed manufacturer models: ASI 0469, ASI 20469 (Curved front), Bobrick B3944, Bobrick B43944 (Curved Front), Bradley 234 and Gamco TW1.

For accessories provided by the University, the design professional shall coordinate installation requirements in the design, including backing, supports, and all required clearances.

For prominent or notable facilities, consult the University's Representative for direction.

Mirrors: Mirrors shall be 1/4" thickness with solid backing. Frames shall be 1/2 inch by 1/2 inch by 1/2 inch heavy duty stainless steel angle, with all corners mitered and welded, Bobrick Series B-165, or equal, sizes as indicated. Tilt mirrors shall be stainless steel with tilt built into frame, Bobrick Model B-293, or equal, sizes as indicated.

Where possible, one soap and paper towel dispenser shall be provided for every two lavatories

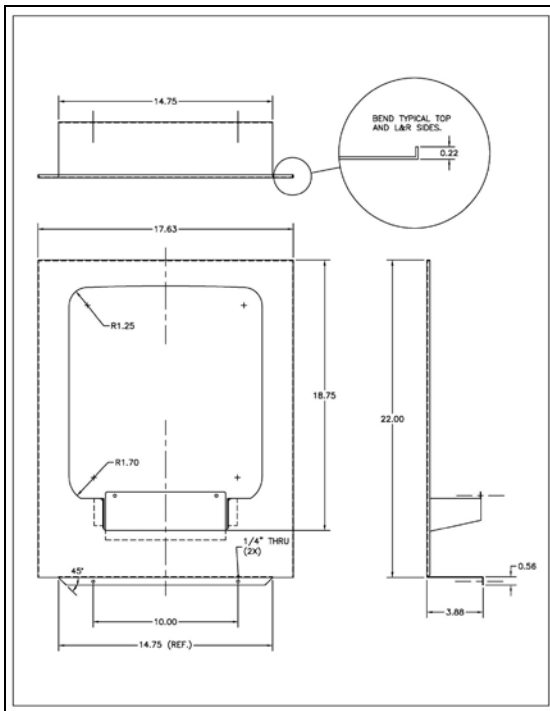

Elevation Washroom Accessory Service and Parts Manual
Tork Elevation Matic Filler Panel 3096020
for 5510202 & 5510282 dispensers

TORK
Revision Date: 11-19-13



Tork Elevation Matic Filler Panel 3096020
For use with Tork Elevation Matic dispenser:
5510202 & 5510282

Panel Specifications:
SS recessed panel for Elevation Matic.
Case pack - 1 part per case
Net Wt. - 3.15 lbs
Gross Wt. - 4.32 lbs
Case size - 23-3/4 x 18-1/4 x 4-1/2
Case code - 1 00 73286 62496 4

Application:
Fits recessed combination towel/waste dispenser where towel dispenser has separate upper half door.

Works with most manufacturers:
ASI models: 0469 & 20469 (Curved door/waste bin)
Bobrick models: B3944 & B43944 (Curved door/waste bin)
Bradley model: 234 & Gamco model: TW1

Fits dispensers:

- 17-1/8" to 17-7/16" wide (outside flange)
- 3-13/16" to 4" deep

Exceptions:
3096020 cannot be used on dispenser with:
a. Full-length door (i.e. Bobrick TrimLine series)
b. 12" wide cabinet
c. Single towel cabinet (without bottom waste bin)
d. Cabinets that are deeper than 4-1/8"



Use with Tork Elevation Matic Dispensers:



5510202 White



5510282 Black

3096020 Filler Panel fits recessed towel dispensers with the following dimensions:

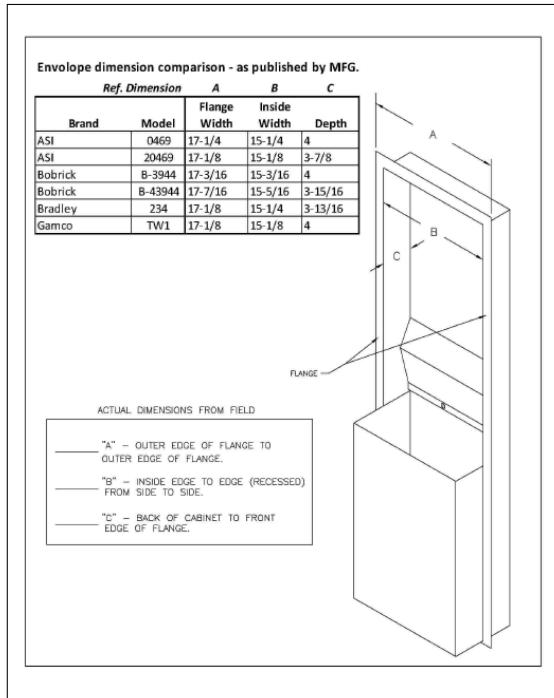

FIRE EXTINGUISHERS

10 44 16

Provide fire extinguishers at residential areas a maximum travel distance of 75' from any location, or a minimum of one per floor. Space according to CCR requirements at all locations. Specify fire extinguisher mounting height per CCR/OSA accessibility requirements.

Fire Extinguishers:

1. Amerex or Badger, to match existing campus standard.

Fire Extinguisher Cabinets:

1. J.L. Industries.
2. Larsen Manufacturing Co.
3. Modern Metal Products by Muckle
4. Or equal

Fire Extinguishers: Provide extinguishers with following UL ratings; aluminum or steel cylinders, rechargeable type.

1. Type 1: 5#ABC; 3A-40BC stored pressure dry chemical type; 5 lb. capacity, approximate 10 lb. shipping weight.
2. Type 2: 10#ABC; 10A-80BC stored pressure dry chemical type; 10 lb. capacity, approximate 20 lb. shipping weight.
3. Type 3: 10#BC; 60-BC stored pressure dry chemical type; minimum 10 lb. capacity, approximate 20 lb. shipping weight.



UC SANTA CRUZ

**BUILDING SIGN PROGRAM
SEPTEMBER 2016**

TABLE OF CONTENTS

INTRODUCTION	3
GENERAL INFORMATION FOR ALL SIGNS	4
SIGN SELECTION CONSIDERATIONS	5
TYPOGRAPHY	6
COLOR SCHEDULE	7
GLOSSARY	8
INTERIOR SIGNS GENERAL INFORMATION	9
SIGN CHECKLIST	11
EXTERIOR	12
INFORMATIONAL	15
CODE	19
SPECIALTY	38

INTRODUCTION

The UC Santa Cruz Building Sign Program is intended to provide design standards for a campus building sign program which will help our signage communicate more effectively through consistency and visual familiarity. These criteria are to aid the design professional in the development of a successful project, meeting the requirements of the University.

The intent of this program is to:

- Provide design standards for a campus building sign program.
- Provide category classification for all sign types in the program.
- Assist in identifying which sign type is appropriate to use.
- Help in developing sign packages for specific areas or facilities.
- Assist in the application and placement of signs.

Exterior wayfinding or informational signs are not covered in this program; any questions regarding these should be directed to the University of California, Santa Cruz Physical Planning & Construction.

The system described in this program provides for consistency of message, appearance, and identity by the use of shape, size, typeface, symbols and wording. Careful implementation of these guidelines will insure a consistent and highly recognizable visual identity for the campus.

Because UC Santa Cruz buildings share similar signing requirements, standardizing information formats for the variety of sign types will develop a consistent, recognizable and cost-effective means of communicating critical information at decisive locations to students and visiting public alike.

It is recognized that the campus is made up of buildings and areas of development which span a range of architectural styles. Some level of variation of interpretation may be considered if deemed appropriate by Physical Planning & Construction.

It is critical that the use of high quality durable materials and proven construction methods be maintained at all times.

If you have questions after you have reviewed these guidelines, contact the University's Representative at Physical Planning & Construction.

GENERAL INFORMATION FOR ALL SIGNS

SIGN PLACEMENT

Signs shall be located to present the necessary information at the point of first exposure to the viewer and meet code requirements.

In selecting the placement of an exterior building sign, consideration must be given to the surrounding terrain, viewing angle, traffic flow and speed.

COLOR

If blue is to be used, specific University colors have been reviewed and approved by the University. Other colors are allowed if that choice would enhance or support a particular interior or architectural design.

SIGN SIZE

The main consideration in determining sign size is the distance from which it must be read, the relative importance of the message, and the length of the message. Also all applicable code sections should be referenced for accessible text height.

SIGN MATERIALS

It is intended that the specific weights, thickness, materials and construction be both durable and of good quality. Edges should be finished and seams and joints should be well executed and acceptable to the University in mock-up form.

DESIGN GUIDELINES DRAWINGS

These are schematic representations of each sign type. These sheets include elevations, plan views and side views where necessary. The designer or sign fabricator will produce a sign schedule, design development drawings and working drawings from these sheets, including more specific construction details which may require engineering from a licensed expert.

SIGN SELECTION CONSIDERATIONS

The sign types in this program have been designed as a comprehensive family of sign types. The hierarchy of sign types extends through the range of informational, directional, identification and code signs. It is the intent of the university that this manual be a reference for anyone programming, designing or selecting a sign, or series of signs for the Campus.

The UC Santa Cruz Sign Program is intended to support applicable current local, state, and national codes and laws.

It is the responsibility of the organization or individual requesting signs to evaluate these laws to ensure that the proposed sign conforms to their requirements. In the event of conflict between these standards and applicable law, the applicable law shall govern.

The signage guidelines shown in this program are to the best of our knowledge in compliance with interpretations of current Americans with Disabilities Act requirements.

If questions arise regarding ADA requirements, a comprehensive interpretation is available from the Society for Environmental Graphic Design.

The Americans with Disabilities Act White Paper
The Society for Environmental Graphic Design
617-577-8225

TYPOGRAPHY

HELVETICA MEDIUM

HELVETICA REGULAR

UNIVERSAL 57 CONDENSED

UNIVERSAL 67 CONDENSED

TIMES NEW ROMAN

(USED FOR MOST SIGNS IN CAMPUS)

GARAMOND



TYPESTYLE

Most signs in UCSC Campus are in “Helvetica Medium or Regular”, though some roadside directional signs use “Universal 57 or 67 condensed”. Building identification depends on the college/building, many of our colleges have their own font. For example: Cowell is “Optima”, Kresge is “Clarendon Bold”, College 9 & 10 uses “Frutiger” and Mc Henry Library uses “MetaNormal Roman”. Fonts can also be compressed down to 85% in order to make long-winded titles fit. The traditional font would be “Times New Roman” or “Garmond”.

It is recommended that only the University standard typefaces be used for signage in all cases.

Fonts specified are readily available to all sign manufacturers. No variations should be approved or accepted.

LOGOTYPE

The UC Santa Cruz logotype is a custom-created mark and is available as a vector line file.

The logo should not be recreated or cloned using alternate typestyles or altered spacing.

The logo and other UC Santa Cruz seals and marks are available from University Communications, or online at: <http://www.ucsc.edu/identity/print/logotypes.html>

PROJECT ARROW

No others are to be used

COLOR SCHEDULE

UC Santa Cruz's official color variants of the traditional University of California blue and gold are central components of the campus's overall identity.

Blue #00458c

Gold #F1B521

UC Santa Cruz Blue

Pantone Matching System® (PMS®) colors

Uncoated paper: 2945U

Matte paper: 541M

Coated Paper: 541C

Process Colors

Uncoated paper: 100C 45M 0Y 14K

Coated Paper (dull, with satin aqueous or varnish coating preferred): 100C 57M 0Y 38K

Coated Paper (dull w/coating, "sophisticated" variant): 100C 57M 0Y 38K

UC Santa Cruz Gold

Pantone Matching System® (PMS®) colors

Uncoated paper: 116U

Matte paper: 1235M

Coated Paper: 1235C 0C 25M 100Y 0K

Process Colors

Uncoated paper: 0C 20M 100Y 0K

Coated Paper (dull, with satin aqueous or varnish coating preferred): 0C 25M 100Y 0K

Coated Paper (dull w/coating, "sophisticated" variant): 0C 25M 100Y 0K

For painted and reflective graphic film applications the following colors have been approved by the University to align with UC Santa Cruz official colors.

- C-1: Benjamin Moore 306 light yellow
- C-2: Benjamin Moore 307 medium yellow
- C-3: Benjamin Moore 308 dark yellow
- C-4: Benjamin Moore 818 light blue
- C-5: Benjamin Moore 819 medium blue
- C-6: Benjamin Moore 826 dark blue
- C-7: 3M #380-75 blue reflective
- C-8: 3M #580-10 white reflective
- C-9: PMS Warm Grey 6
- C-10: White
- C-11: Black

GLOSSARY

BASELINE

A typographic term referring to the imaginary line along which the bottom edge of most lower case and all capital letters align.

CAPITAL HEIGHT

A typographic term referring to the height of a capital letter. The letter “E” should be used as an example in all cases of type measurement.

FAÇADE

The front of a building (or any side given special architectural treatments).

FLUSH LEFT

A typographic term referring to two or more lines of type, set to align vertically at a left margin.

LETTERSPACING

The spaces between letters within a word.

LOGOTYPE

The University name displayed in specially drawn letters.

RETURN

The side (or the depth) of a dimensional letter, symbol or an entire sign.

SYMBOL

The standardized mark, letter, or abbreviation used to represent something as an image. It is recommended to accompany the use of symbols with the supporting copy when possible.

WORD SPACING

The spaces between words in copy.

INTERIOR SIGNS GENERAL INFORMATION

Every campus facility has interior sign requirements that are unique to that particular building's layout, interior design and function. This design guide offers sign standards for signage which informs, directs and identifies. This sign program will serve to assist anyone who is going to program, design or implement signage. Every facility should be programmed to ascertain sign copy requirements and a sign schedule.

The sign system is designed to direct a visitor from the entry area or lobby to a room or an individual through a hierarchy of sign types beginning with a building or floor directory and ultimately leading to room identification signs.

Directional signs facilitate circulation about the building and offer guidance from the lobby to the desired destination. Informational signs use short verbal messages or pictorial symbols to convey information in the clearest manner.

Office identification signage includes a room number and occupant name(s). A logical and consistent room numbering system should be developed.

The flexible sign system is designed to accommodate paper laser print inserts for changeable information such as names and titles.

Conference rooms or special-function rooms shall be identified with a room number and name of function. Other miscellaneous permanent spaces must be identified by number and name.

MATERIAL

Sign faces will be 1/16" thick on ¼" backs. Face inserts will slide in to facilitate cleaning and maintenance.

COLOR

The material of interior signs should be a color which is coordinated with the building interior. All signs within a building should be a consistent color.

Colors should come from Rowmark or similar, not painted or silkscreened. Rowmark products are preferred, but the color should be chosen from a stock list to avoid any high costs if the sign needs to be replaced in the future.

It is intended that the building user select a color paper stock for inserts in order for the sign package to be coordinated with the building's interior colors and finishes.

Changeable messages on interior signs are black text on a color paper stock. Room number identification is black or white text on an etched polymer background painted a contrasting color. Braille is not to be painted.

PLACEMENT

It is recommended that signs be installed using the following guidelines, some of which are driven by code and ADA:

- Wall mounted directories and signs should be mounted depending on the size of the directory. Most of the time, they are mounted at 4-feet to 5-feet to the center of the sign.
- Restroom signs should be mounted at 5-feet 0-inches to the center of the sign.
- Overhead signs should be mounted to a minimum clearance of 6-feet 8-inches to the bottom of the sign.

- Room bulletin boards should be mounted directly below a room sign with a 2-inch space in between.

CAP HEIGHT

- Room ID header 5/8-inch tactile cap height, all caps.
- Restroom ID 1-inch silkscreened cap height, all caps.
- Restroom ADA 1-inch tactile cap height, all caps.

NOTE: The designer is responsible to check current California Building Code and ADA standards prior to preparing detailed drawings to ensure compliance with the most current standards.

SIGN CHECKLIST

All projects must provide a sign plan, schedule and sign details sheet. Including but not limited to:

EXTERIOR

- Exterior Building Mounted Signage
- Address Signage
- Smoke and Tobacco Free Signage

INTERIOR: CODE REQUIRED

- Room Identification Sign
- Room Number and/or Name Identification Sign
- Room Number and Identification Sign
- Restroom Door Signage
- Accessible Restroom Door Signage
- Accessible Restroom Location
- Stairway Identification Sign
- Tactile Floor Identification
- Alternate Path of Egress
- Accessible Exit Sign
- Accessible Exit Ramp
- Accessible Exit Route
- Accessible Exit Stair
- Accessible Area of Refuge
- Emergency Evacuation Signage
- Fire Riser Inside
- FACP Inside
- Occupancy Sign
- Assisted Listening Device
- No Roof Access

INTERIOR: WAYFINDING

- Directional Signage
- Informational

INTERIOR: SPECIALTY

- Electronic Display
- Caution Placard

EXTERIOR 1

BUILDING MOUNTED

Where it is necessary to identify a building on the façade, signage shall be a UC Santa Cruz standard typography. Times New Roman or Garamond are more common in Campus. Helvetica is much more common in modern architecture. Also, whether freestanding or wall-mounted, building identification signs need to be prominent and easy to read. For buildings with multiple entries, Wayfinding Group should be part of the project.

Signage should be a minimum 6-inch tall, 3/4-inch deep, and no larger than visually necessary and mounted on the first building story. Signage may be mounted on an exterior building wall, landscape feature wall, or on an entrance arch.

Signage material should withstand weather abuse; 3/4-inch fabricated metal lettering is suggested. Finish should be easily readable, durable and coordinate with the building architecture.

Care should be taken such that signage is securely fixed and location deters theft or vandalism.

EXTERIOR 2

ADDRESS SIGNAGE

For all new and existing buildings, the address numerals must be located in a position that is plainly legible and visible from the street, road, or area of the assigned address.

All numbers must be Campus Standard font style. Confirm the placement with the University's Representative and UC Santa Cruz Fire Marshal.

Below is the current mock up (Text height is 4" white on a 7.5" x 12" black landscape rectangle)



EXTERIOR 3

SMOKE AND TOBACCO FREE SIGNAGE

Install signage at the main entries to the building. Window clings or stickers to be provided by University.

Locations as follows:

- Double glass sliding doors. Install on right fixed side panel not on door, 1.5 inches from left edge of panel, 7 inches from bottom of panel.
- Double glass doors with side glass panels. Install on right fixed side panel not on door, 1.5 inches from left edge of panel, 1.5 inches below cross bar.
- Double glass doors without side glass panels. Install on right door, 1.5 inches from left edge of glass panel, 1.5 inches below cross bar.
- Single glass door with side glass panel. Install on side panel that is adjacent to the door handle, 1.5 inches from edge of glass panel in line with door handle.
- Single glass door with side glass panels with cross bars or mullions. Install on side panel that is adjacent to the door handle, 1.5 inches from edge of glass panel, 1.5 inches below mullion.
- Single glass door without side panels. Install on door on side with door handle, 1.5 inches from edge of solid door material, 1.5 inches below the exit bar or 2.5 inches if door handle is in conflict.
- Doors without glazing. Install 1.5 inches below door handle components.

INFORMATIONAL 1

PRIMARY DIRECTIONAL

FLAG MOUNT – WALL MOUNT

These signs are for wayfinding use at corridor intersections and wall mounted applications. The sign carries directional information to rooms and facilities, individual message strips are used for flexibility.

MATERIAL

- Backer panel – Project specific
- Insert area – Non-glare acrylic
- Insert – Laserprint copy on selected stock

TYPEFACES

Insert – Times New Roman



INFORMATIONAL 2

PRIMARY INFORMATIONAL

These signs are for a wall mounted application. The sign carries information pertinent to rooms and facilities; a reproducible laserprint insert on stock paper is used for flexibility.

If affixed to glass, provide a blank backer panel on reverse side.

MATERIAL

- Backer panel – Project specific
- Insert area – Non-glare acrylic
- Insert – Laserprint copy on selected stock

TYPEFACES

Insert – Times New Roman

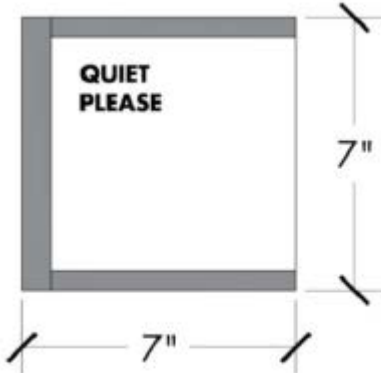
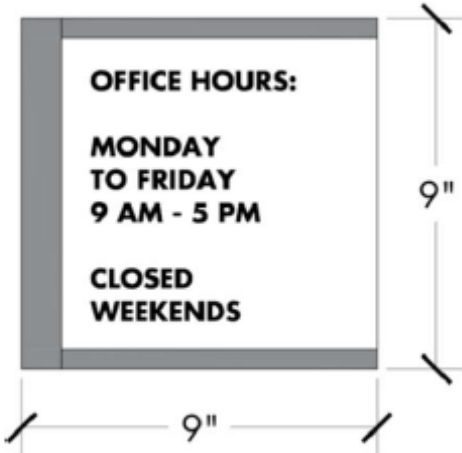

Scale: 3" = 1'-0"

INFORMATIONAL 3

SECONDARY INFORMATIONAL WALL MOUNT

Secondary Informational Wall Mount Signs shall include building and room specific messages. For laboratory room signage, laboratory faucets served by industrial water shall be labeled "Industrial Water – Do Not Drink".

MATERIAL

- Sign panel – Project specific
- Message panel – Project specific
- Symbol – Vinyl or raised recommended
- Copy – Vinyl or raised copy recommended

TYPEFACES – Times New Roman

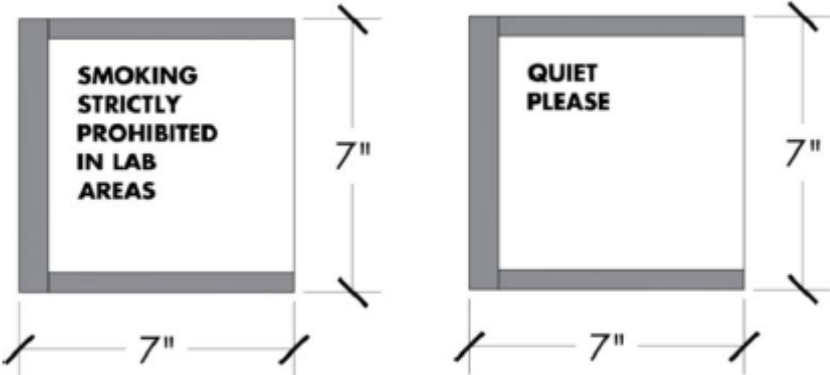

Scale: 3" = 1'-0"

INFORMATIONAL 4

SECONDARY INFORMATIONAL FLAG MOUNT

MATERIAL

- Sign panel – Project specific
- Message panel – Project specific
- Symbol – Vinyl or raised recommended
- Copy – Vinyl or raised copy recommended

TYPEFACES

Times New Roman

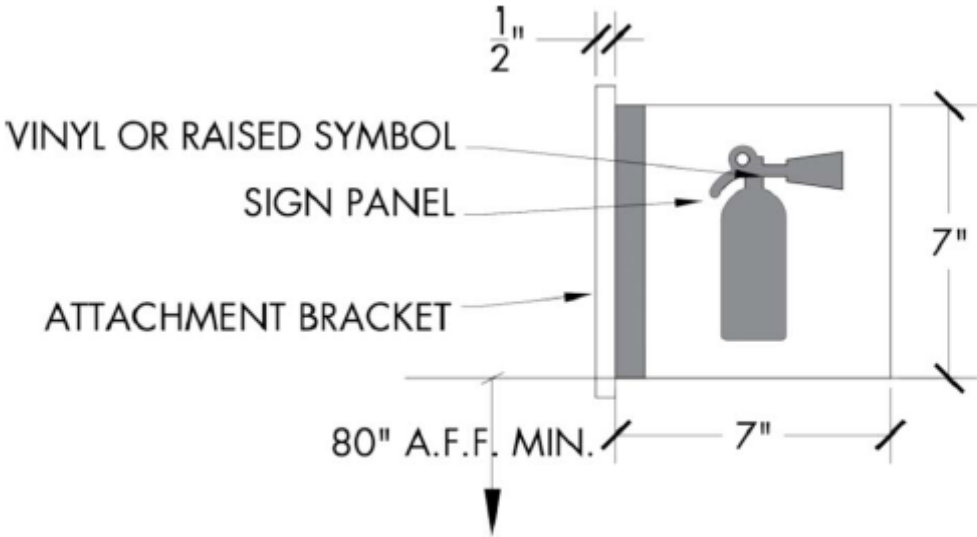

Scale: 3" = 1'-0"

CODE 1

PRIMARY ROOM IDENTIFICATION

MATERIAL

Header panel – Project specific

Backer panel – Project specific

Header copy – Raised copy

TYPEFACES

Header – Times New Roman

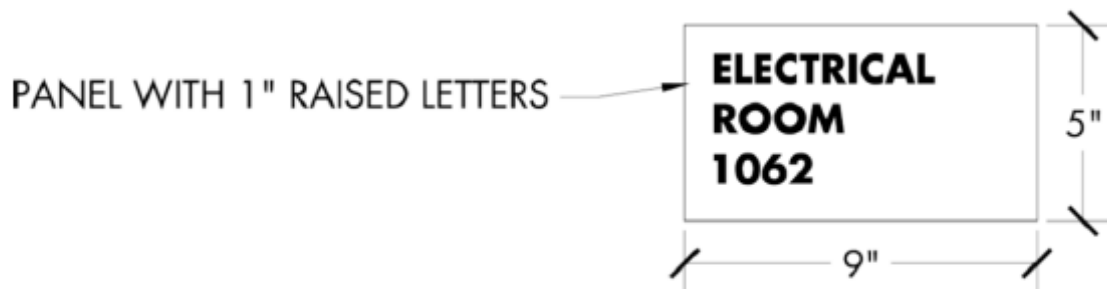

Scale: 3" = 1'-0"

CODE 2

ROOM NUMBER AND/OR NAME IDENTIFICATION

MATERIAL

- Header panel – Project specific
- Header copy – Raised copy
- Backer panel – Project specific
- Insert area – Non-glare acrylic
- Insert – Laserprint copy on selected stock

TYPEFACES

Times New Roman

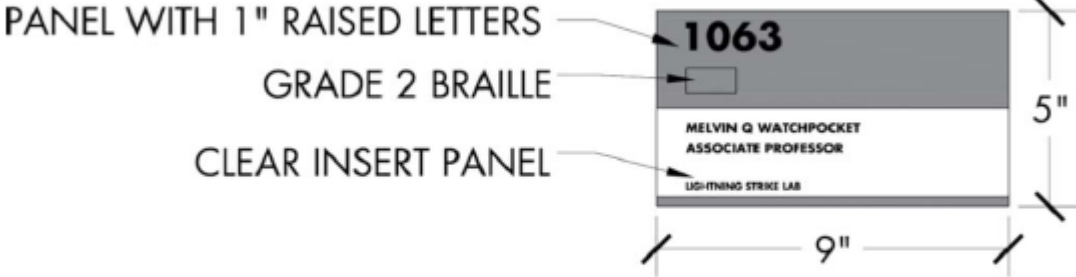

Scale: 3" = 1'-0"

CODE 3

ROOM NUMBER & IDENTIFICATION

MATERIAL

Header panel – Project specific

Header copy – Raised copy

TYPEFACES

Times New Roman

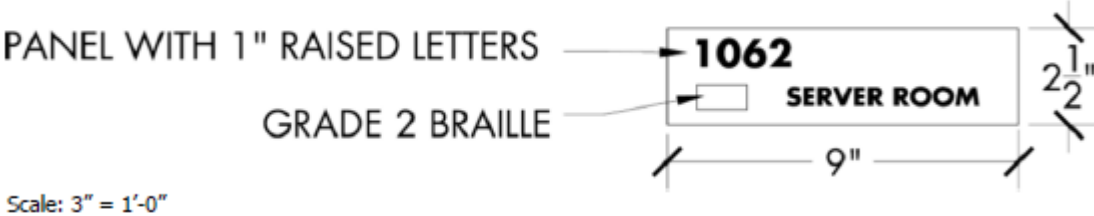

CODE 4

RESTROOM DOOR SIGN

Pictograms or lettering M or W; if lettering is used it must be 6-inches high.

MATERIAL

Sign panel – Project specific

Copy – Project specific

Symbol – Project specific

TYPEFACES

Times New Roman

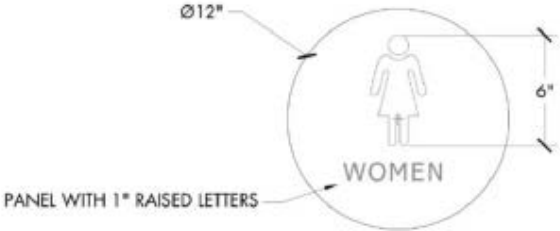
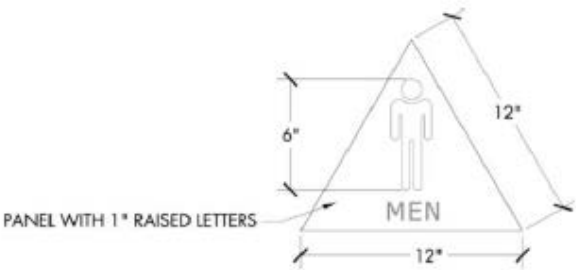

Scale: 1 1/2" = 1'-0"



CODE 5

ACCESSIBLE RESTROOM SIGN

MATERIAL

- Sign panel – Project specific
- Copy – Project specific
- Symbol – Project specific

TYPEFACES

Times New Roman



- * Include the international symbol of accessibility if applicable
- * ADD a line for the Room number between the pictogram and the text, or above the text as applicable

CODE 6

DISABLED ACCESSIBLE RESTROOM DIRECTIONAL

MATERIAL

- Sign panel – Project specific
- Backer Panel – Project specific
- Copy – Vinyl, or raised copy recommended

TYPEFACES

Times New Roman

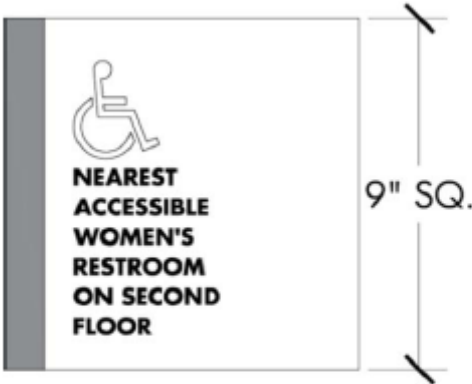

Scale: 3" = 1'-0"



* Include the international symbol of accessibility if applicable

CODE 7

STAIR IDENTIFICATION

Tactile floor identification signs shall be located at each floor level landing placed adjacent to the door on the latch side, in all enclosed stairways in buildings two or more stories in height to identify the floor level. At exit discharge level, the sign shall include a raised five-pointed star located to the left of the identifying floor level. The outside diameter of the star shall be the same as the height of the raised characters. If this sign is not readily visible when the doors are in the open and closed position from 5 feet above the floor landing, provide a Tactile Floor Identification Sign adjacent to the door, and a separate Stairway Identification Sign.

MATERIAL

- Sign panel – Project specific
- Backer Panel – Project specific
- Copy – Vinyl, or raised copy recommended
- Braille – To match background color of sign

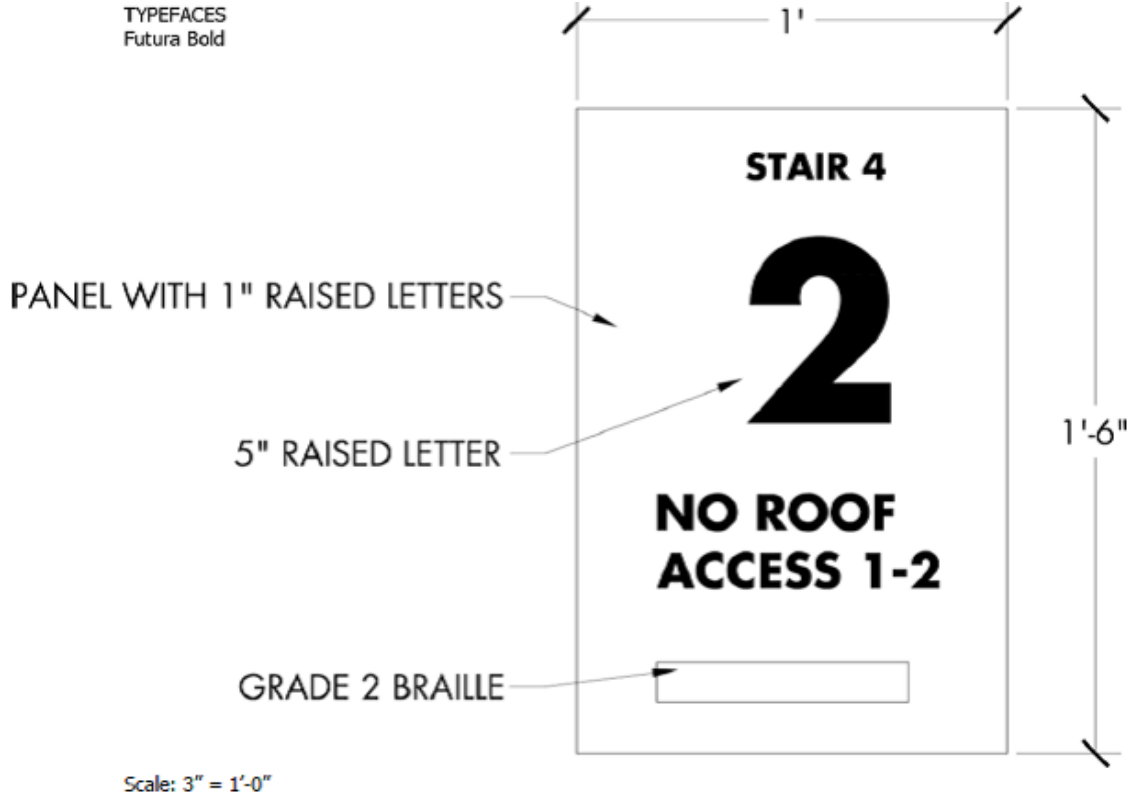

CODE 8

TACTILE FLOOR IDENTIFICATION

MATERIAL

- Sign panel – Project specific
- Backer Panel – Project specific
- Copy – Vinyl, or raised copy recommended
- Braille – To match background color of sign

TYPEFACES

Times New Roman

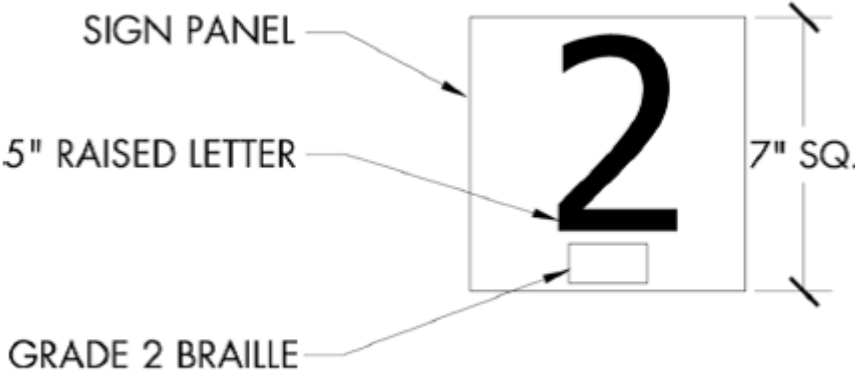

Scale: 3" = 1'-0"

CODE 9

ALTERNATE PATH OF EGRESS

MATERIAL

Sign panel – Project specific

Backer Panel – Project specific

Copy – Vinyl, or raised copy recommended

Braille – To match background color of sign

TYPEFACES

Times New Roman

7" x 7" with 0.6" text, 4" person on stair and 2.5" flames.
There is no braille on this sign.



**In Case of Fire
Do Not Use Elevator
Use Stairways**

CODE 10

ACCESSIBLE EXIT SIGN

MATERIAL

Sign panel – Project specific

Backer Panel – Project specific

Copy – Vinyl, or raised copy recommended

Braille – To match background color of sign

TYPEFACES

Times New Roman

6" x 3", 1" raised text and grade 2 braille



CODE 11

TO ACCESSIBLE EXIT SIGN

MATERIAL

- Sign panel – Project specific
- Backer Panel – Project specific
- Copy – Vinyl, or raised copy recommended
- Braille – To match background color of sign

TYPEFACES

Times New Roman

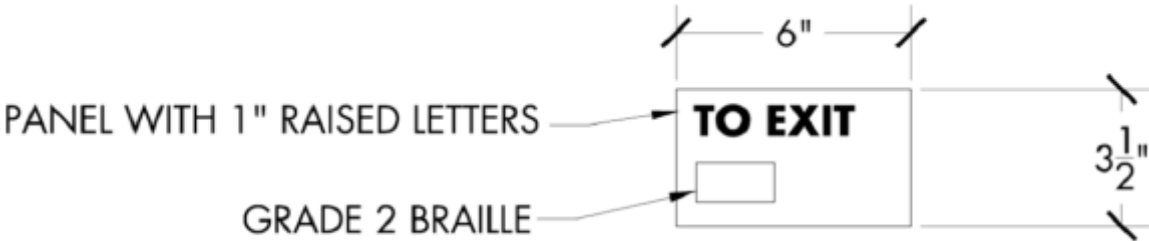

Scale: 3" = 1'-0"

CODE 12

ACCESSIBLE EXIT ROUTE

MATERIAL

- Sign panel – Project specific
- Backer Panel – Project specific
- Copy – Vinyl, or raised copy recommended
- Braille – To match background color of sign

TYPEFACES

Times New Roman

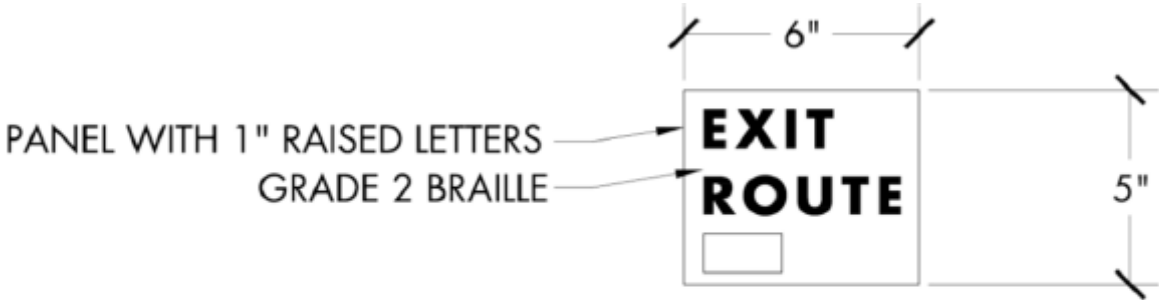

Scale: 3" = 1'-0"

CODE 13

ACCESSIBLE EXIT ROUTE/RAMP/STAIR

MATERIAL

- Sign panel – Project specific
- Backer Panel – Project specific
- Copy – Vinyl, or raised copy recommended
- Braille – To match background color of sign

TYPEFACES

Times New Roman

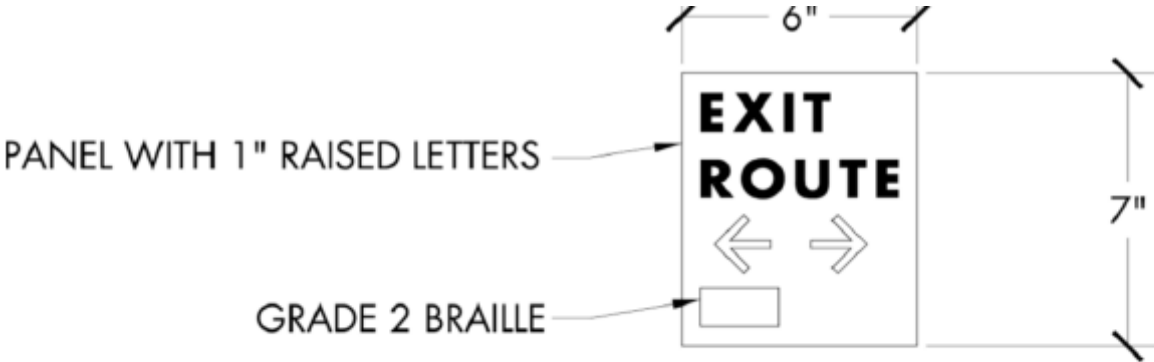

Scale: 3" = 1'-0"

CODE 14

ACCESSIBLE AREA OF REFUGE

MATERIAL

- Sign panel – Project specific
- Backer Panel – Project specific
- Copy – Vinyl, or raised copy recommended
- Braille – To match background color of sign

TYPEFACES

Times New Roman

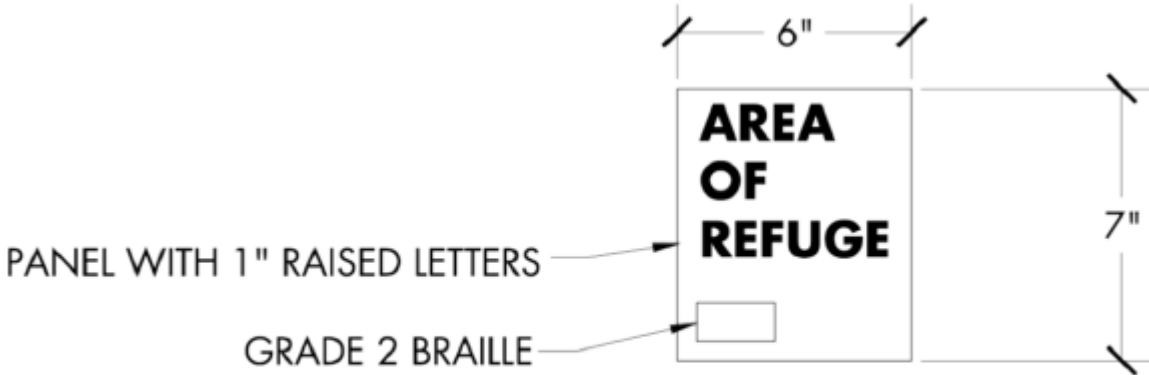

Scale: 3" = 1'-0"

CODE 15

EMERGENCY EXIT MAP

All campus buildings over one story high shall have building evacuation signs posted on every floor. The signs shall be posted at all stairway and elevator landings and immediately inside all public entrances to the building (California Code of Regulations, Title 19).

MATERIAL

Sign panel – Project specific

Backer Panel – Project specific

Insert holder – Non-glare acrylic

Floor plan shall be fixed in the sign and not an Insert Laserprint copy. UCSC have had issues with inserts. The students take them and they need to be replaced frequently.

Copy – Vinyl, or raised copy recommended

TYPEFACES

Times New Roman

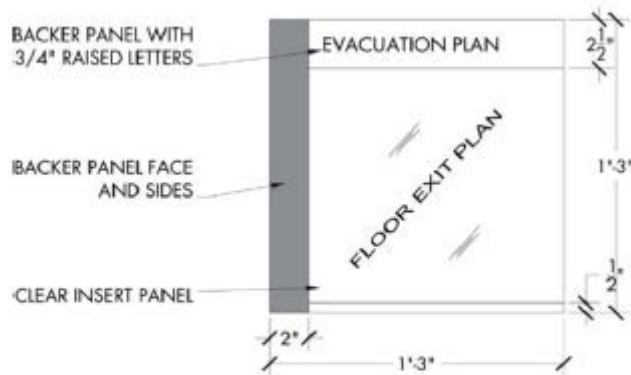

Scale: 1 1/2" = 1'-0"

CODE 16

FACP INSIDE AND FIRE RISER INSIDE

Provide signs at doors for "FACP INSIDE" and "FIRE RISER INSIDE". Signs shall be 10-inches x 14-inches with a red border and red lettering on white background.

MATERIAL

- Sign panel – Project specific
- Backer Panel – Project specific
- Copy – Vinyl

TYPEFACES

Times New Roman - 1-3/8-inch lettering

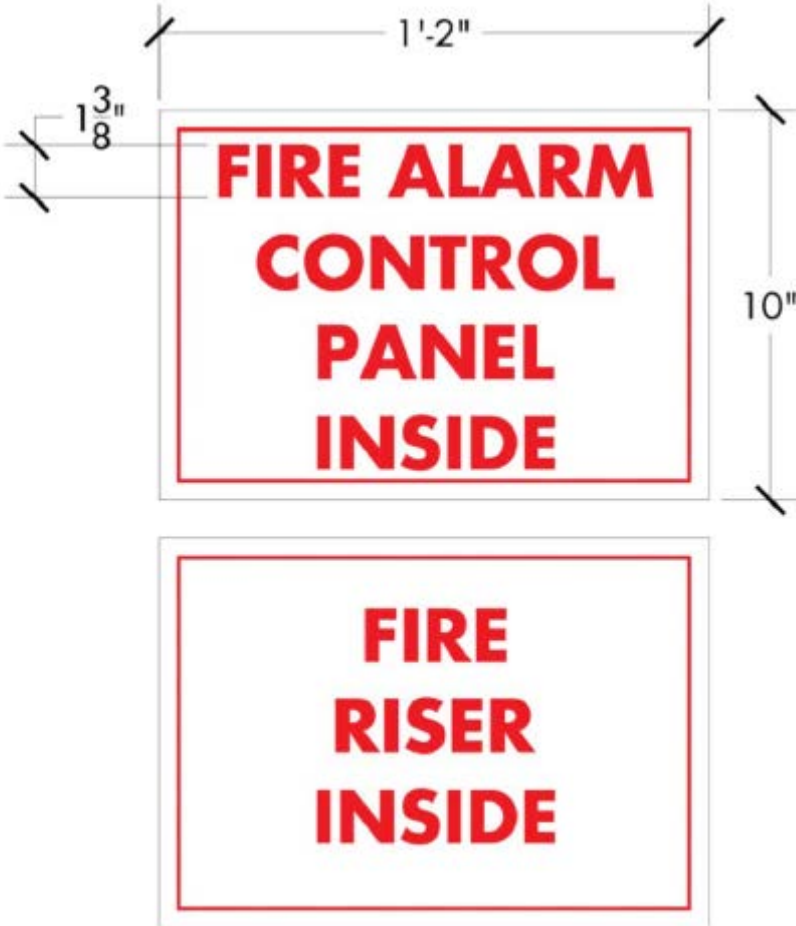

Scale: 3" = 1'-0"

CODE 17

OCCUPANCY SIGN

Sign panel – Project specific
Copy – Raised copy

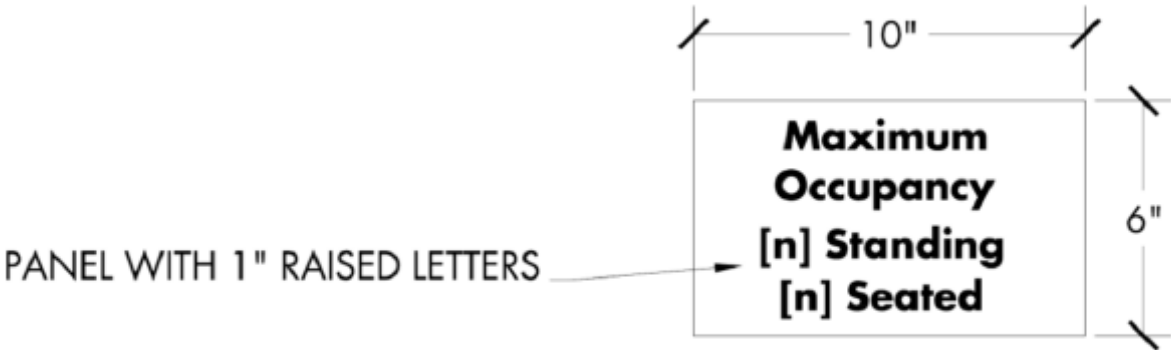

Scale: 3" = 1'-0"

CODE 18

ASSISTED LISTENING DEVICE

Sign panel – Project specific
Copy – Raised copy



Scale: 3" = 1'-0"

CODE 19
NO ROOF ACCESS
Sign panel – Project specific
Copy – Raised copy

PANEL WITH 1" RAISED LETTERS

Scale: 3" = 1'-0"



SPECIALTY 1

CAUTION PLACARD

MATERIAL

- Header panel – Project specific
- Backer panel – Project specific
- Insert area – Non-glare acrylic
- Insert – Laserprint copy on selected stock

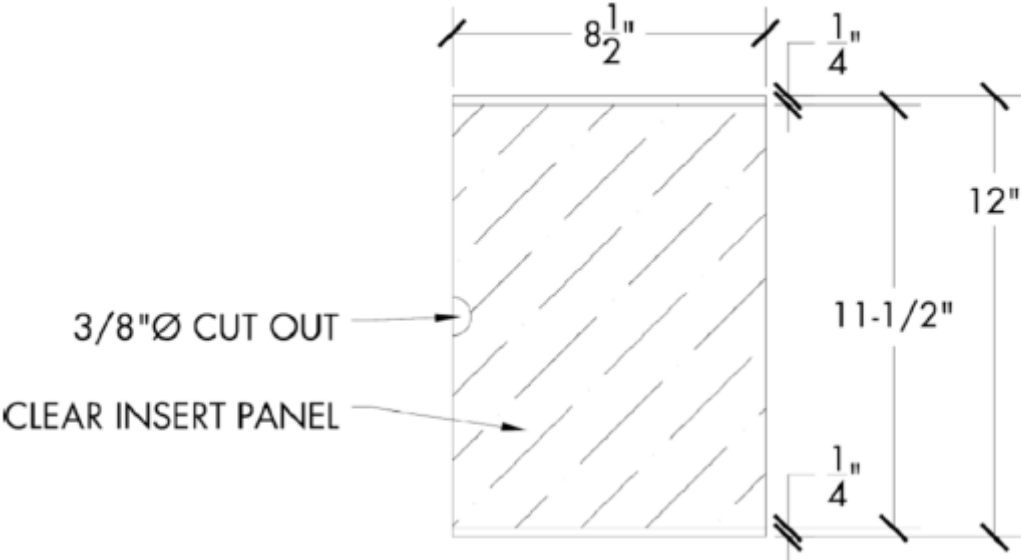

SPECIALTY 2

ELECTRONIC DISPLAY

Maximum height for any operational aspect of an electronic display shall be 48 inches. Wall mounted electronic displays shall not be more than 4 inches off the wall or 27 inches off the floor, if either, an apron must be provided. Comply with CBC 1133B.8.6.1. Any interactive electronic display (such as an information kiosk) needs to meet UC's Electronic Accessibility requirements. Their procurement guidelines can be found here:

<http://www.ucop.edu/electronic-accessibility/standards-and-best-practices/procurement/index.html>